

DALLAS B CLEAR 2017

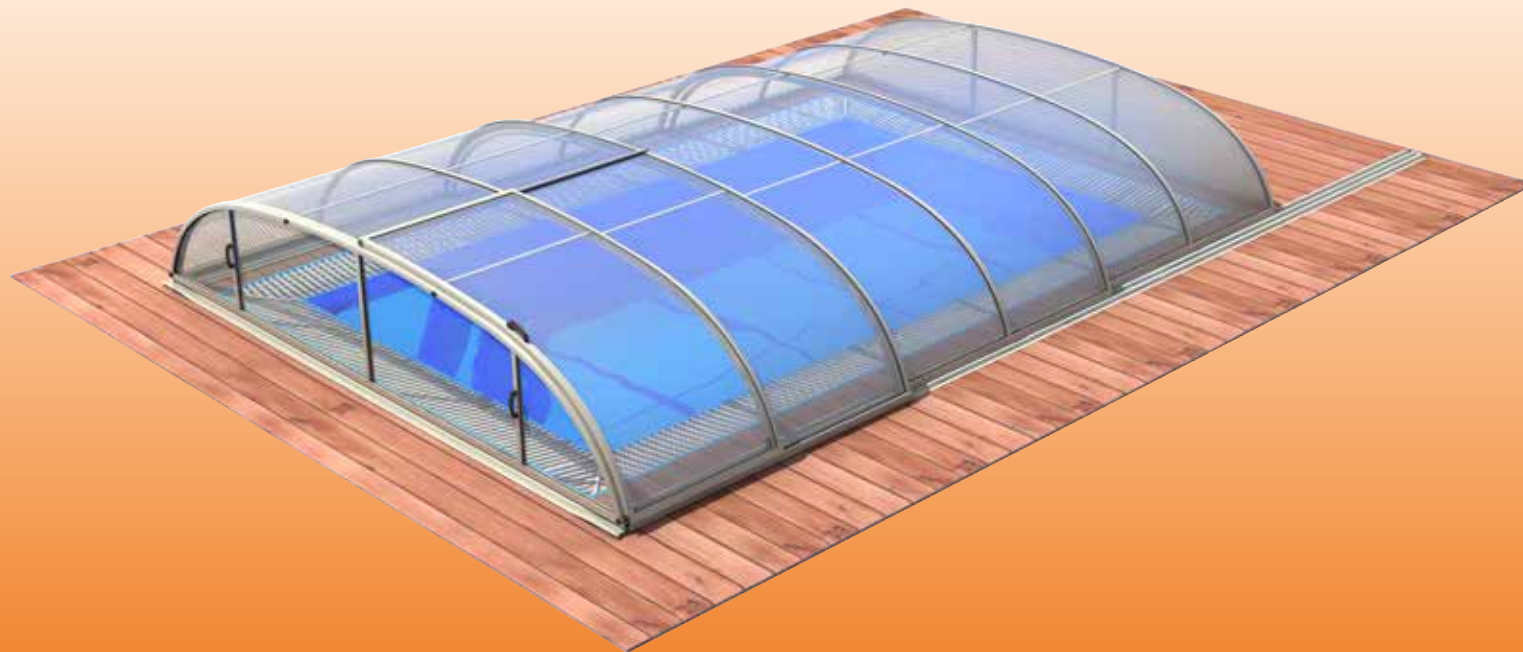

VERZE: 5. 10. 2017 / REVIZE: 5. 10. 2017

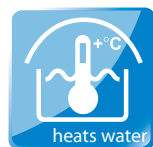

BG
 Тръгването на Слънцето: нова конструкция
 Enclosure avec ANCOR - NF P 90-300
 Застава за слънцето: нова конструкция с изключително висока прозрачност и енергийно ефективност. Не е необходима допълнителна изолация или отопление.

DE
 Schwimmbeckenüberdachung: neue Konstruktion
 Enclosure avec ANCOR - NF P 90-300
 Die Schwimmbeckenüberdachung ist eine innovative Konstruktion, die eine hervorragende Transparenz und Energieeffizienz bietet. Eine zusätzliche Isolierung oder Heizung ist nicht erforderlich.

ES
 Cubierta de piscinas: nueva forma
 Enclosure avec ANCOR - NF P 90-300
 Este tipo de cubierta es una solución innovadora y eficiente que no requiere aislamiento ni calefacción adicional.

FR
 Hors de piscine: nouvelle forme
 Enclosure avec ANCOR - NF P 90-300
 Cette nouvelle forme est une solution innovante et efficace qui ne nécessite ni isolation ni chauffage supplémentaire.

HU
 Működőcsőfedő: új formatervezés
 Enclosure avec ANCOR - NF P 90-300
 A működőcsőfedő új formatervezése innovatív és hatékony megoldás, amely nem igényel további szigetelést vagy fűtést.

CN
 阳光房: 新设计
 阳光房: 新设计
 Enclosure avec ANCOR - NF P 90-300
 阳光房是一种创新的、高效的解决方案，不需要额外的隔热或加热。

LT
 Šilumos vieta šiluminė apsauga
 Enclosure avec ANCOR - NF P 90-300
 Šilumos vieta šiluminė apsauga yra inovatyvi ir efektyvi konstrukcija, kuri nereikalauja papildomos izoliacijos ar šildymo.

PL
 Zastawienie basenów: nowa konstrukcja
 Enclosure avec ANCOR - NF P 90-300
 Zastawienie basenów to nowa konstrukcja, która nie wymaga dodatkowej izolacji ani ogrzewania.

RU
 Тёплое место: новая конструкция
 Enclosure avec ANCOR - NF P 90-300
 Тёплое место: новая конструкция, которая не требует дополнительной изоляции или отопления.

SL
 Toplotno mesto: nova konstrukcija
 Enclosure avec ANCOR - NF P 90-300
 Toplotno mesto: nova konstrukcija, ki ne zahteva dodatne izolacije ali ogrevanja.

CZ
 Sluneční zastavení: nová konstrukce
 Enclosure avec ANCOR - NF P 90-300
 Sluneční zastavení: nová konstrukce, která nevyžaduje další izolaci ani ohřevání.

DK
 Bænkoverdækning: ny konstruktion
 Enclosure avec ANCOR - NF P 90-300
 Bænkoverdækning: ny konstruktion, der ikke kræver yderligere isolering eller opvarmning.

EE
 Päikesäilitähted: uus konstruktsioon
 Enclosure avec ANCOR - NF P 90-300
 Päikesäilitähted: uus konstruktsioon, mis ei vaja täiendavat isoleerimist ega kütet.

GB
 The swimming pool enclosure: new design
 Enclosure avec ANCOR - NF P 90-300
 The swimming pool enclosure: new design, which does not require additional insulation or heating.

HR
 Nadzračna bazena: nova konstrukcija
 Enclosure avec ANCOR - NF P 90-300
 Nadzračna bazena: nova konstrukcija, koja ne zahtijeva dodatnu izolaciju ili grijanje.

IT
 Copertura per piscine: nuova struttura
 Enclosure avec ANCOR - NF P 90-300
 Copertura per piscine: nuova struttura, che non richiede ulteriore isolamento o riscaldamento.

LV
 Baidzīnu jumts: jauna konstrukcija
 Enclosure avec ANCOR - NF P 90-300
 Baidzīnu jumts: jauna konstrukcija, kas ne prasa papildu izolāciju vai sildību.

RO
 Acoperitură pentru piscină: nouă structură
 Enclosure avec ANCOR - NF P 90-300
 Acoperitură pentru piscină: nouă structură, care nu necesită izolație suplimentară sau încălzire.

SE
 Pooltak: ny konstruktion
 Enclosure avec ANCOR - NF P 90-300
 Pooltak: ny konstruktion, som inte kräver ytterligare isolering eller uppvärmning.

SK
 Slnečné zastavenie: nová konštrukcia
 Enclosure avec ANCOR - NF P 90-300
 Slnečné zastavenie: nová konštrukcia, ktorá nevyžaduje ďalšiu izoláciu ani ohrevanie.

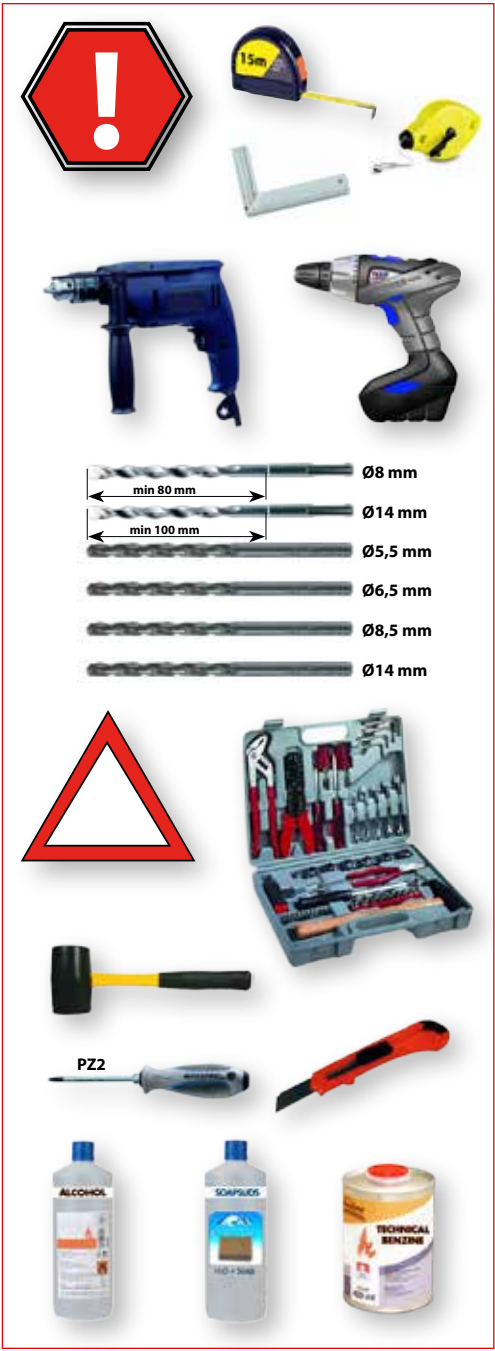

DIN 7982
4,8 x 13
20x
1

650.01.8811.2
16x
2

AN 9051
6,3 x 50
36x
3

007.20.1501.2
6x
4

DIN 7976
6,3 x 38
6x
5

650.01.0021.2
4x
6

007.02.0030.2
ø4 x 10
80x
7

007.20.1605.2
1x
8

007.10.7012.2
ø8 x 80
88x
9

007.02.0092.2
ø4 x 14
6x
11

007.90.4505.2
4x
12

AN 9051
6,3 x 38
20x
13

ø4,2
1x
14

1x
17

1x
18

097.02.0046.2
3x
19

097.02.0047.2
3x
20

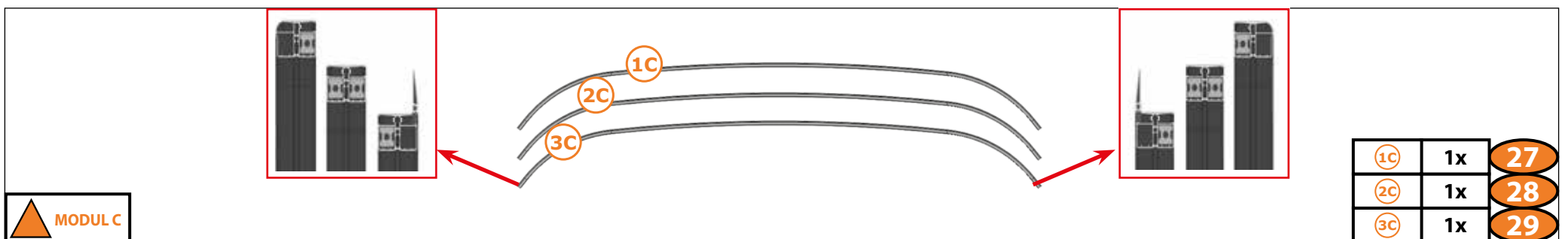
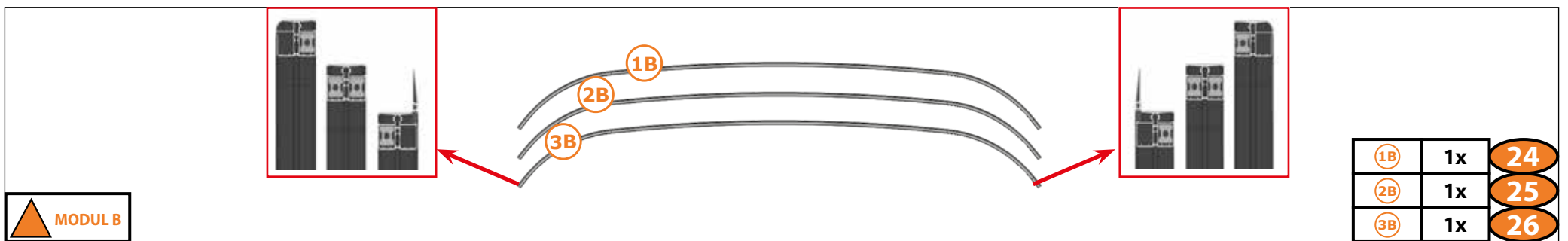
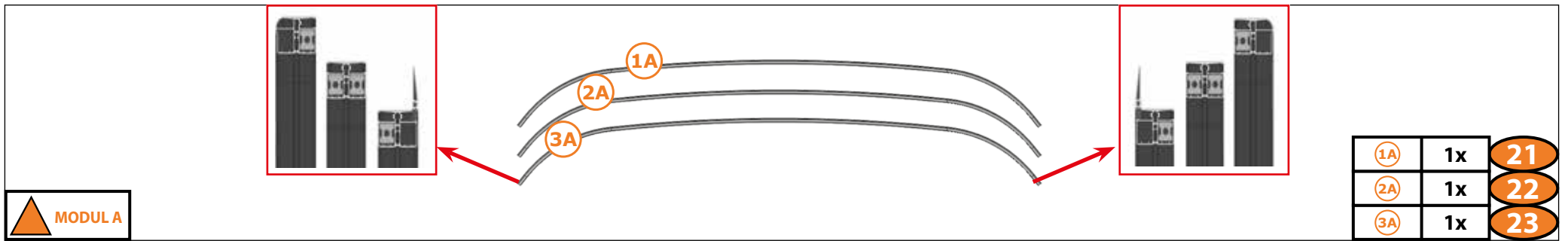
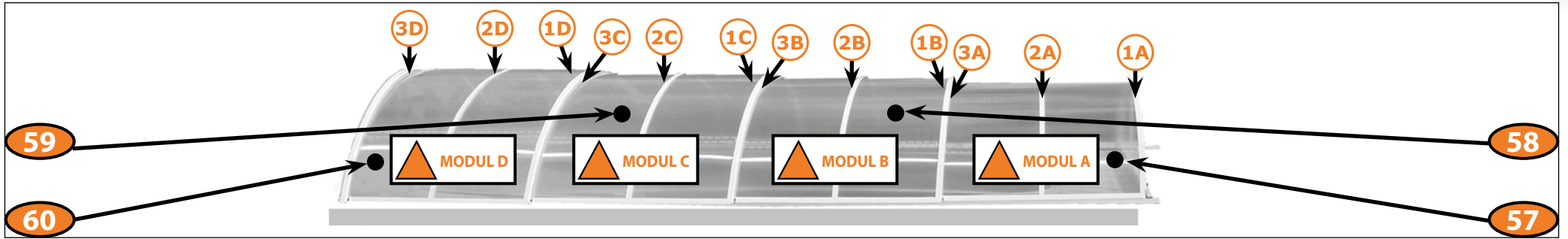



MODUL D

1D	1x	30
2D	1x	31
3D	1x	32

1041 mm
38x
36

A
3230 mm
4x
41

B
2140 mm
4x
43



Technical specifications for Dallas B Clear 2017:

D
3230 mm
4x
47

Technical specifications for Dallas B Clear 2017:

D
3230 mm
16x
48

Technical specifications for Dallas B Clear 2017:

D
2140 mm
8x
49



MODUL D

1x
50

MODUL D

1x
51

MODUL C
MODUL B

2x
52

MODUL C
MODUL B

2x
53

Diagram illustrating the assembly of Modul A (54). The assembly consists of a central cable with four end components. The components are shown in four red-bordered boxes: a hook-shaped end, a component with a small protrusion, a component with a larger protrusion, and a hook-shaped end with a black knob. Red arrows point from the central cable to the second and third components. To the right, a label indicates "MODUL A" and "1x 54".

Diagram illustrating the assembly of Modul A (55). The assembly consists of a central cable with four end components. The components are shown in four red-bordered boxes: a hook-shaped end with a black knob, a component with a small protrusion, a component with a larger protrusion, and a hook-shaped end. Red arrows point from the central cable to the second and third components. To the right, a label indicates "MODUL A" and "1x 55".



Diagram showing two Modul A units. UV rays are shown entering from the left and being blocked by the units. An 'OUT' label is on the left. Dimensions: 5066 x 1049 mm. Quantity: 2x. Item number: 57.

2x
57

Diagram showing two Modul B units. UV rays are shown entering from the left and being blocked by the units. An 'OUT' label is on the left. Dimensions: 5265 x 1049 mm. Quantity: 2x. Item number: 58.

2x
58

Diagram showing two Modul C units. UV rays are shown entering from the left and being blocked by the units. An 'OUT' label is on the left. Dimensions: 5467 x 1049 mm. Quantity: 2x. Item number: 59.

2x
59

Diagram showing three Modul D units. UV rays are shown entering from the left and being blocked by the units. An 'OUT' label is on the left. Dimensions: 2831 x 1049 mm. Quantity: 3x. Item number: 60.

3x
60

Diagram showing one Modul unit. UV rays are shown entering from the left and being blocked by the unit. An 'OUT' label is on the left. Dimensions: 2784 x 1049 mm. Quantity: 1x. Item number: 61.

1x
61

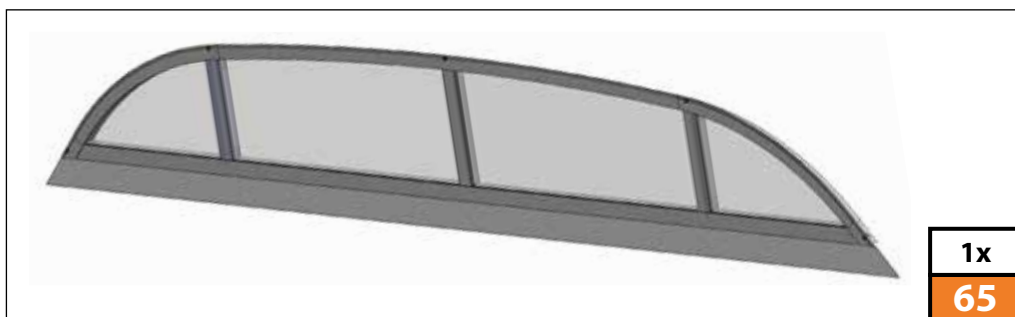
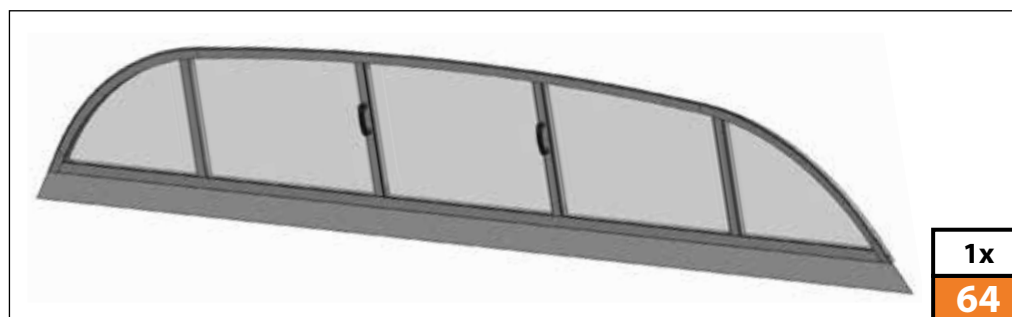



1x
69

1x
70

2150 mm 1x
71

2150 mm 1x
72

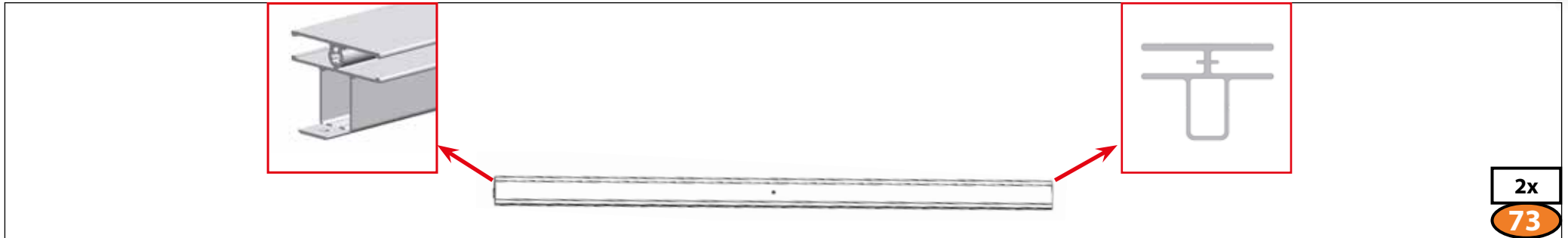

2x
73

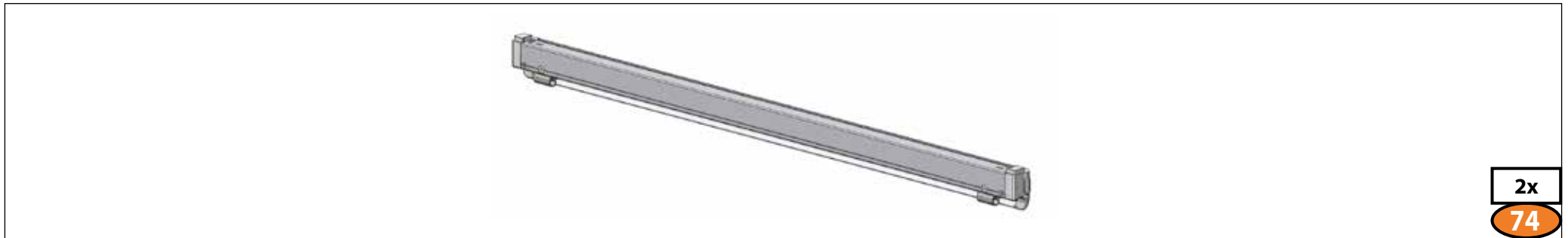

2x
74

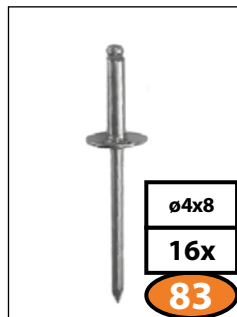
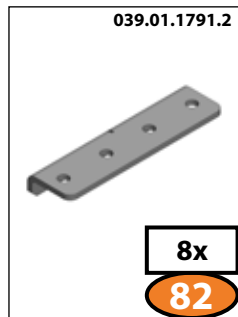
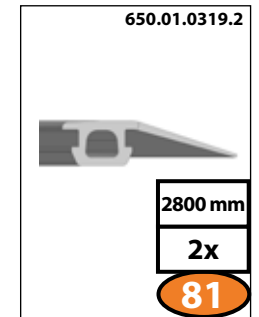
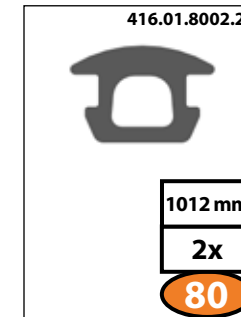
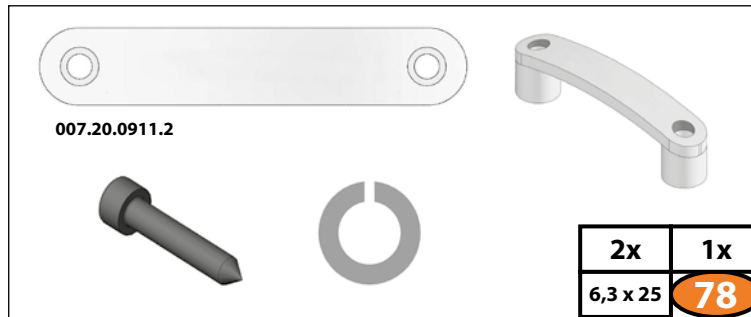
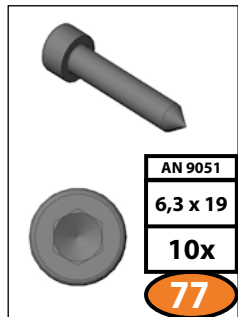
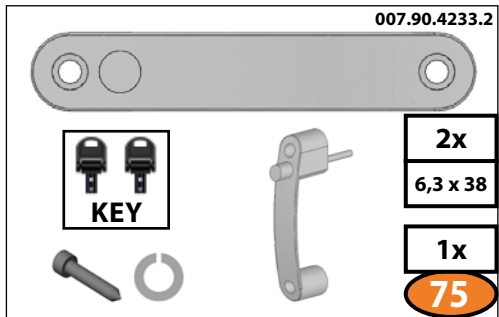



5066 mm	4x
1030 mm	4x

MODUL A

92

5265 mm	4x
1030 mm	4x

MODUL B

93

5467 mm	4x
1030 mm	4x

MODUL C

94

2831 mm	6x
1030 mm	6x

MODUL D

95

2784 mm	2x
1030 mm	2x

MODUL

96

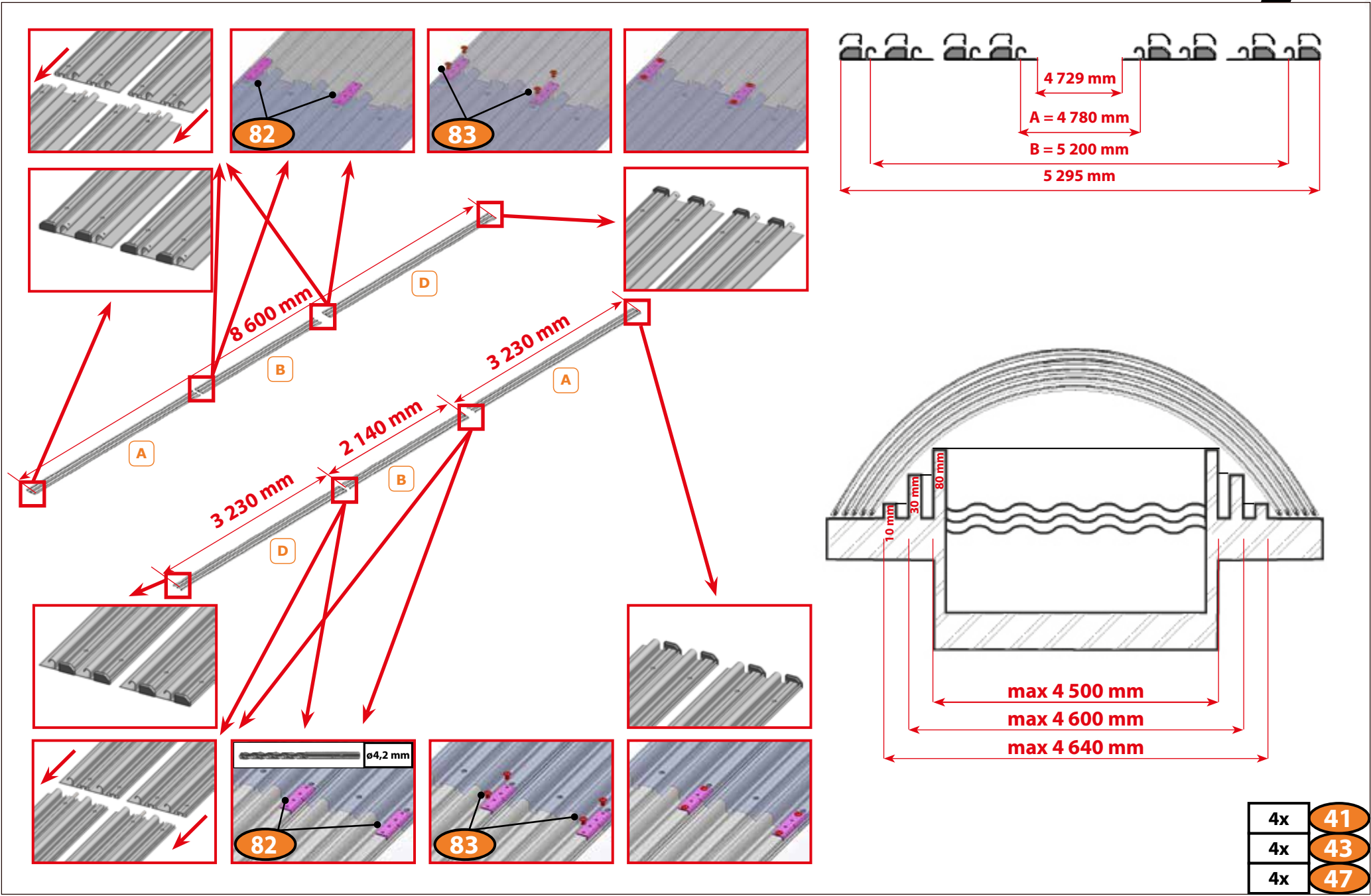

4x	41
4x	43
4x	47

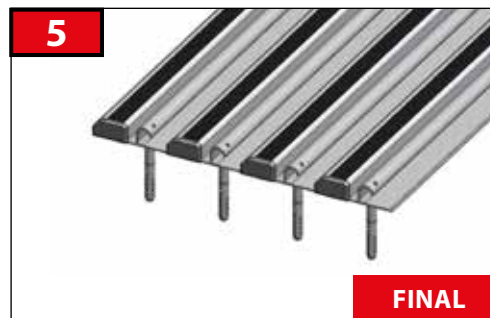
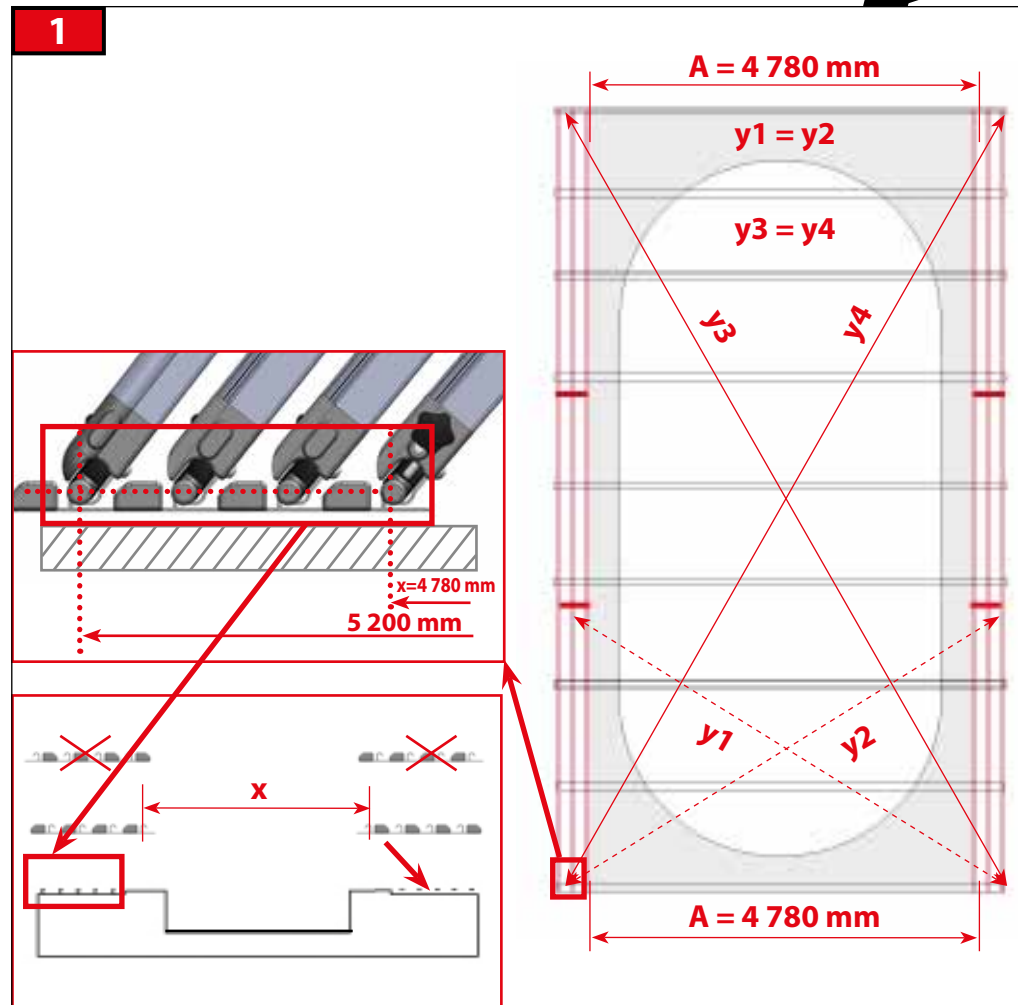
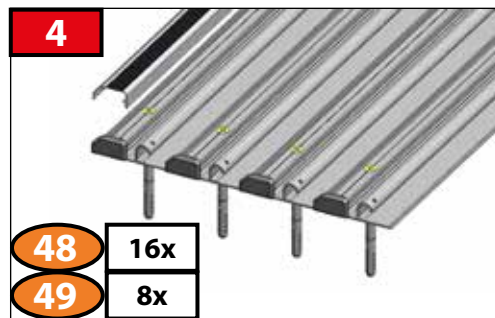
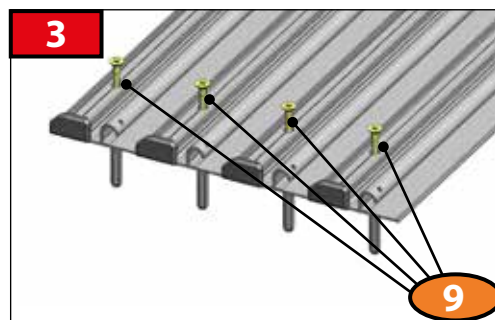
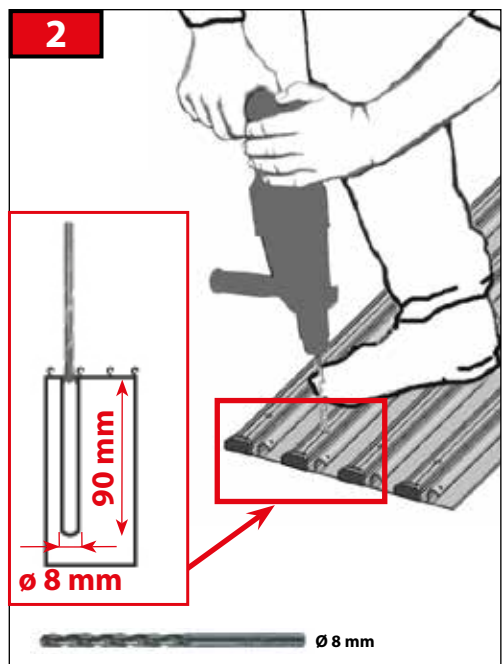
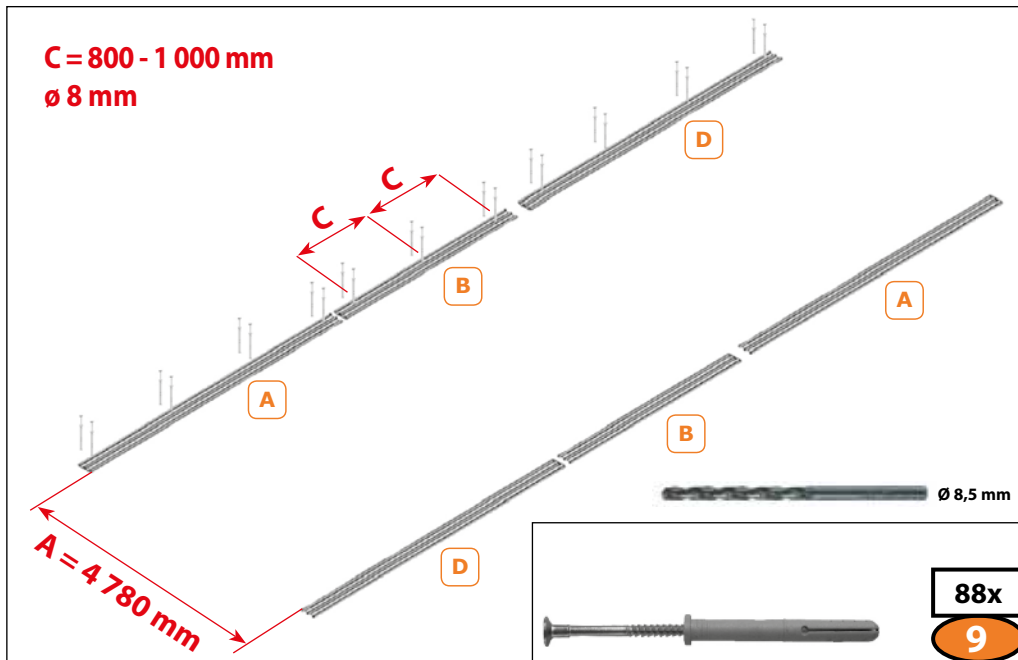

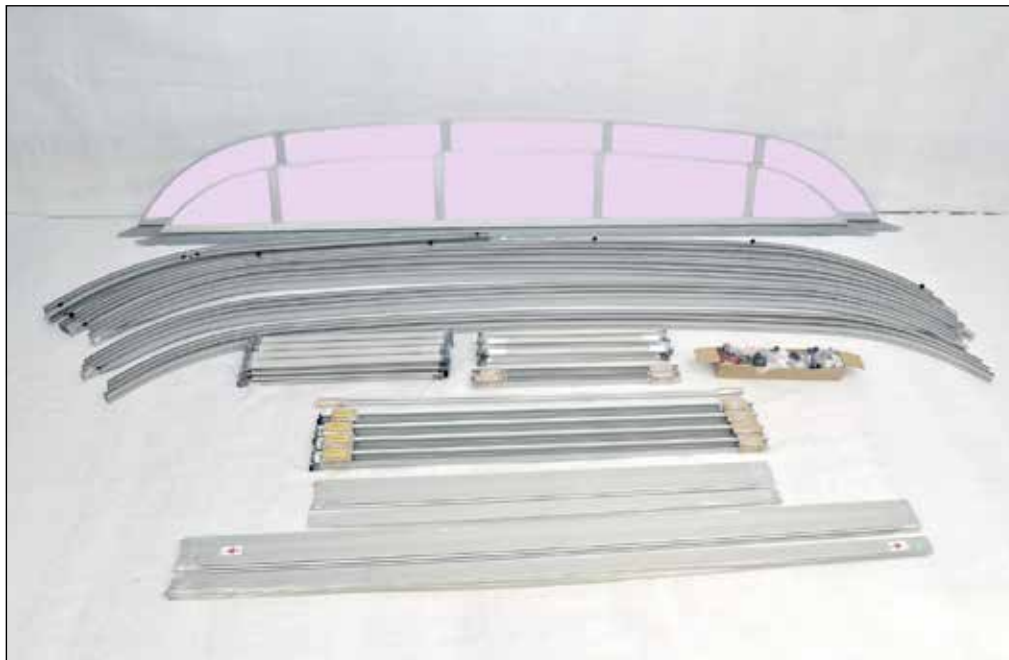

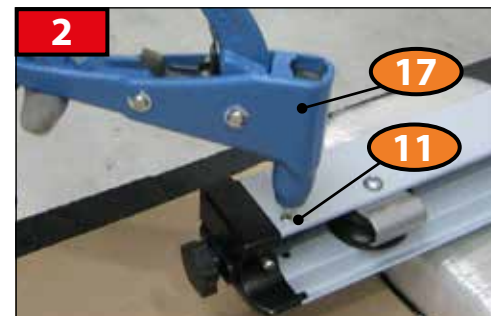
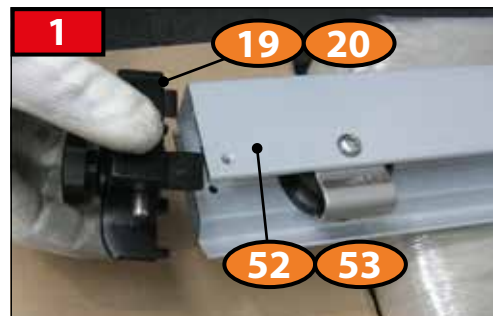
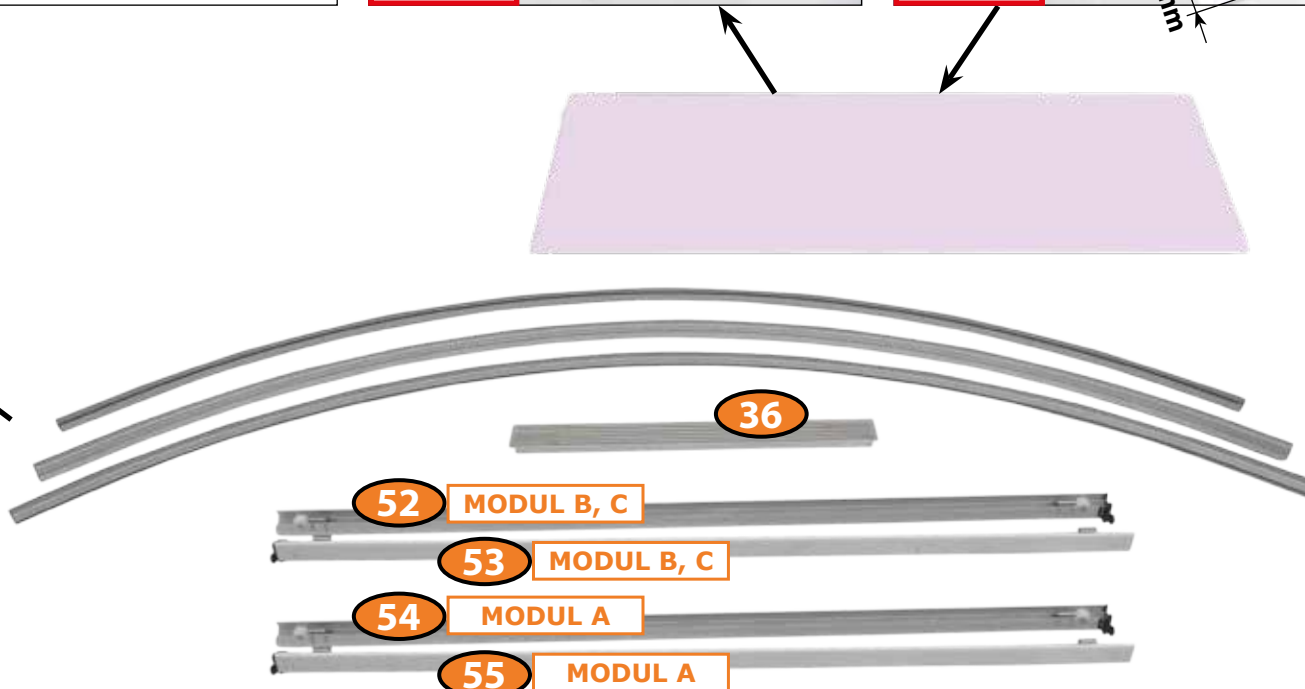
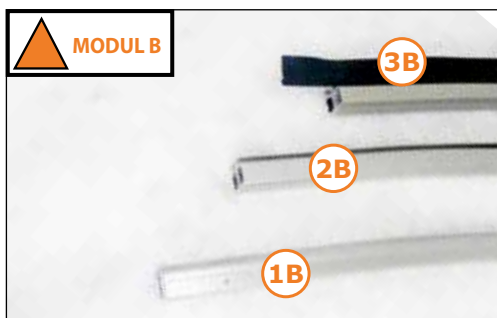
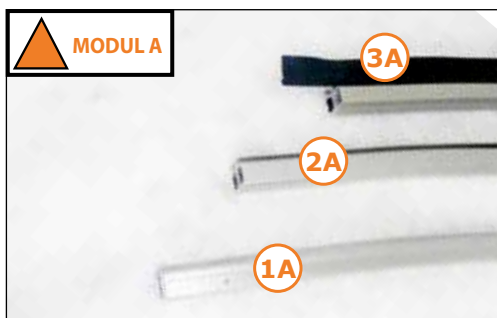

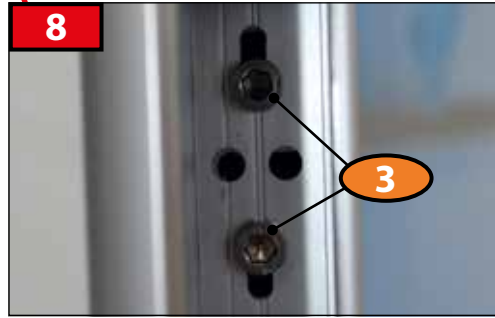
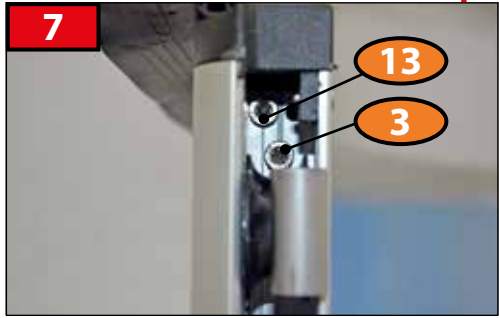
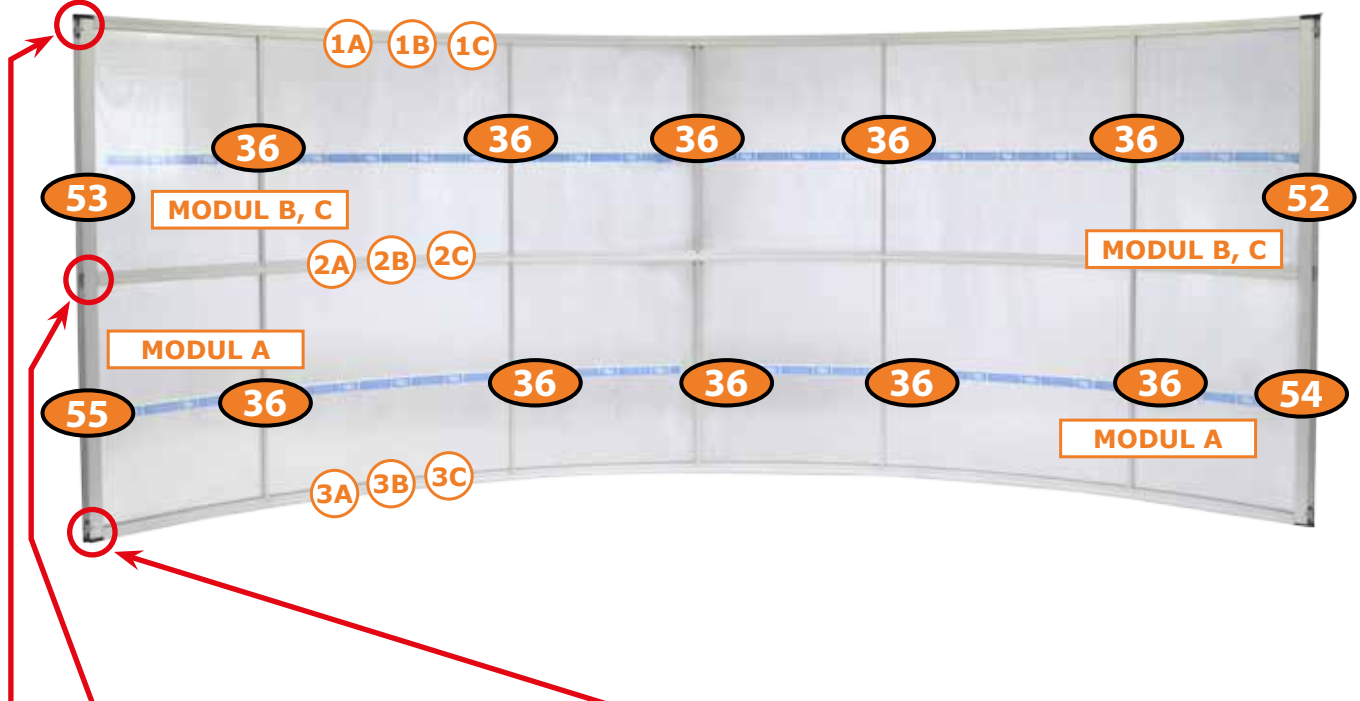
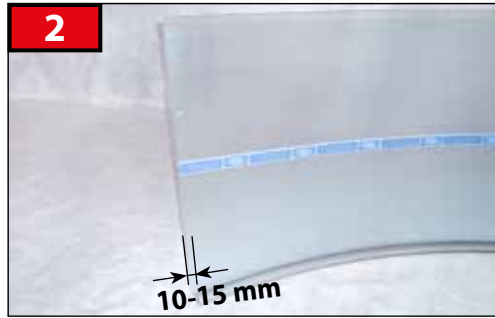

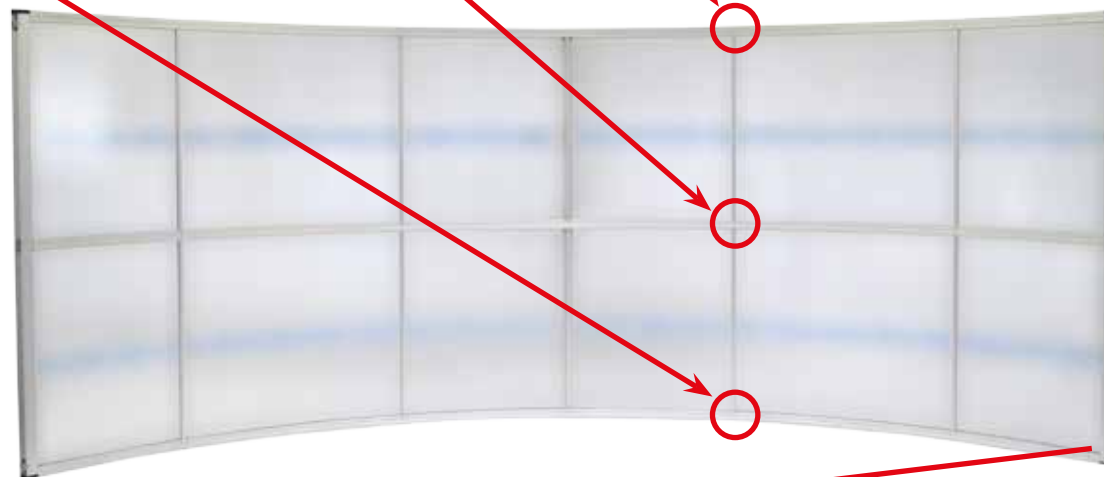

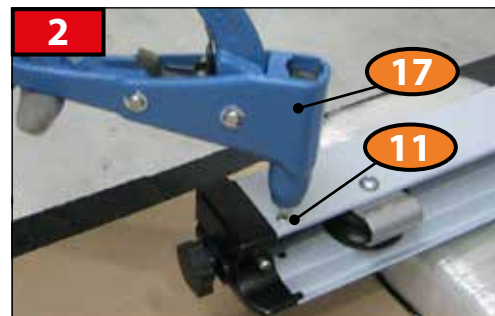
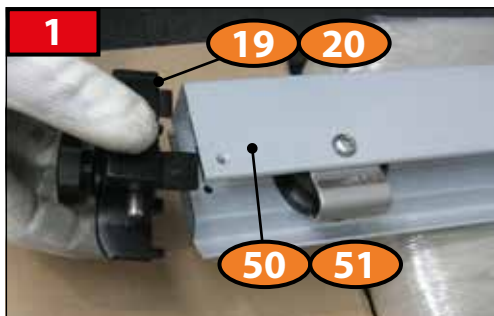
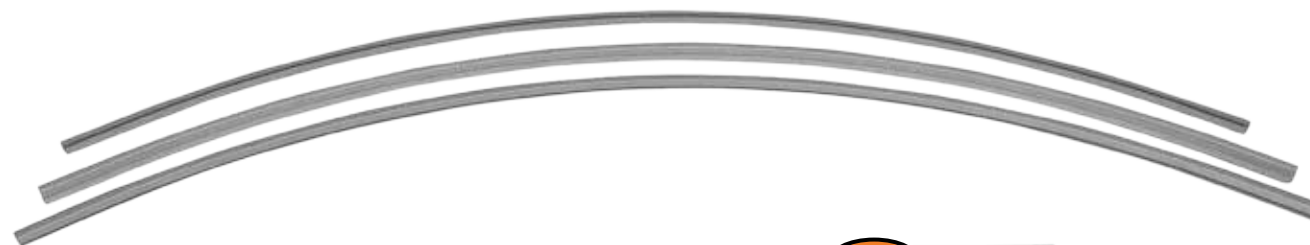
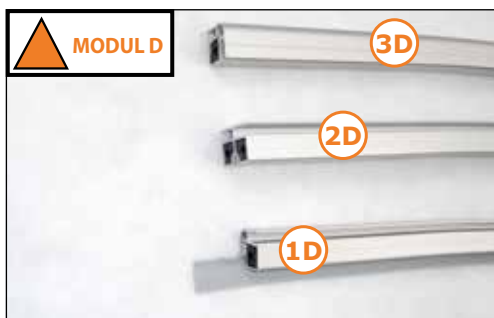



DOOR LEFT

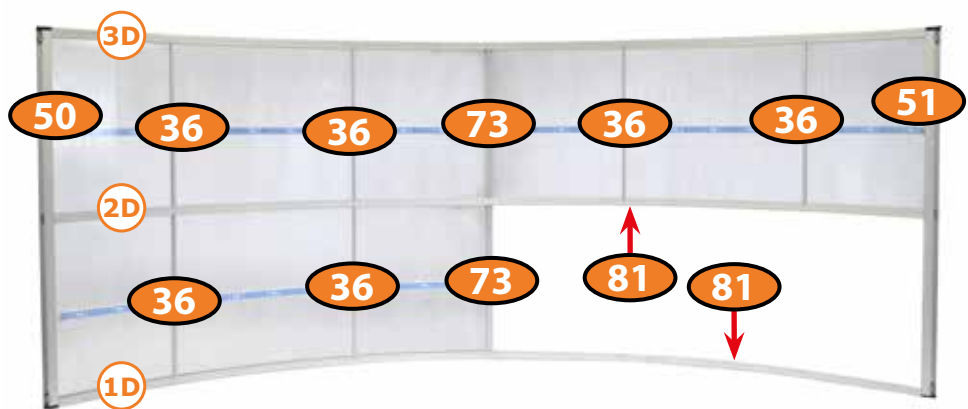
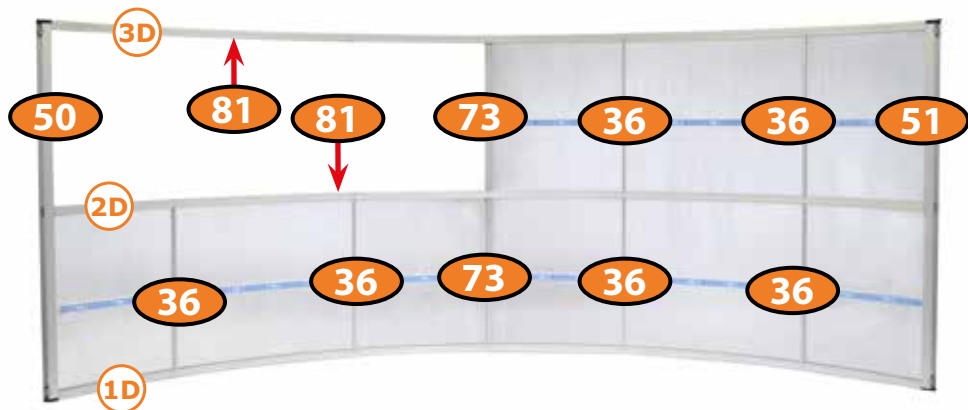

DOOR RIGHT

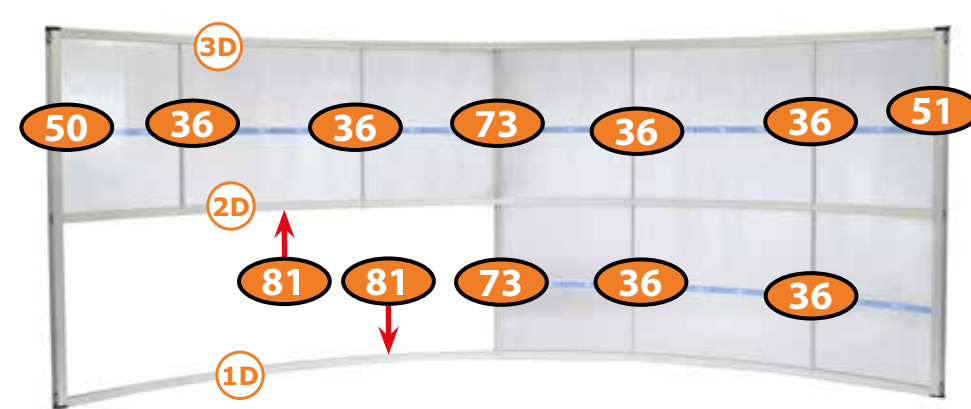
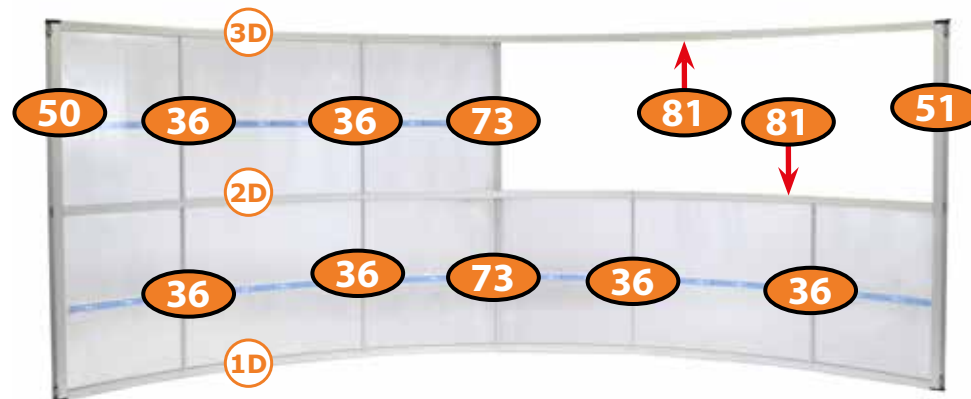

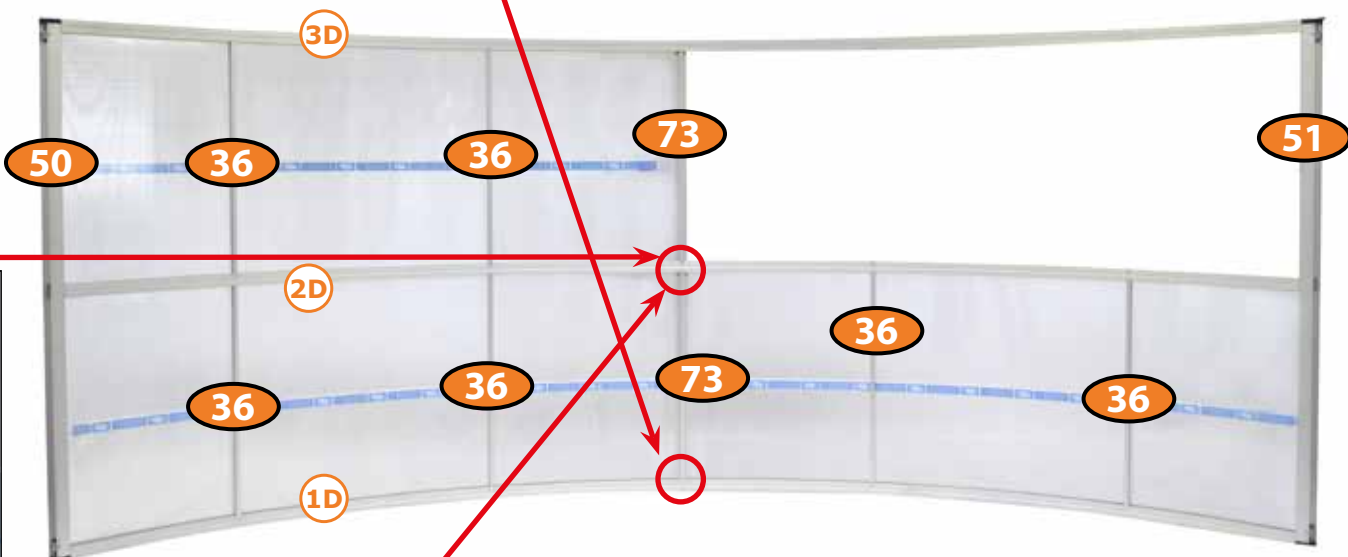

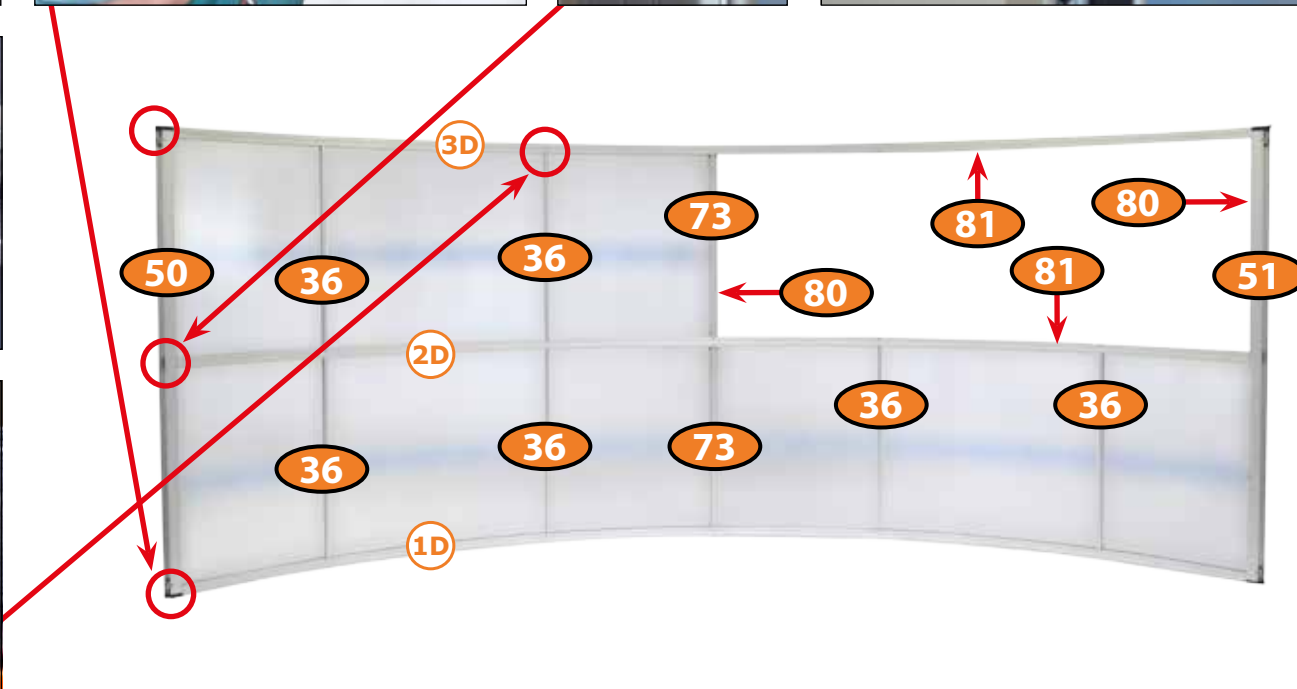
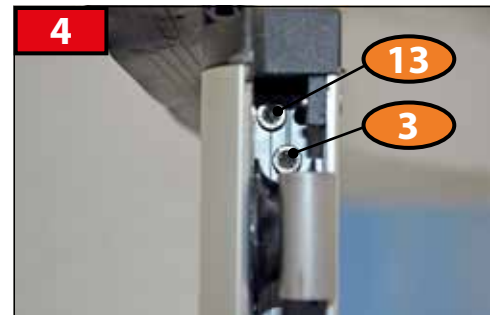

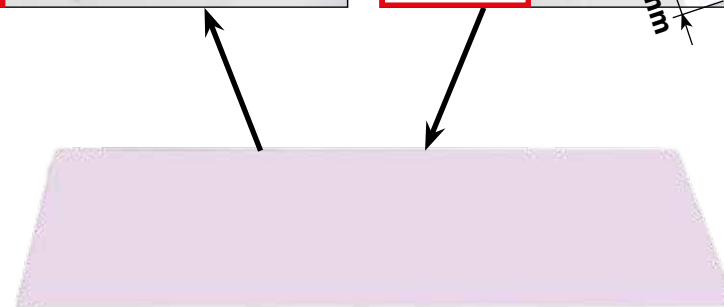
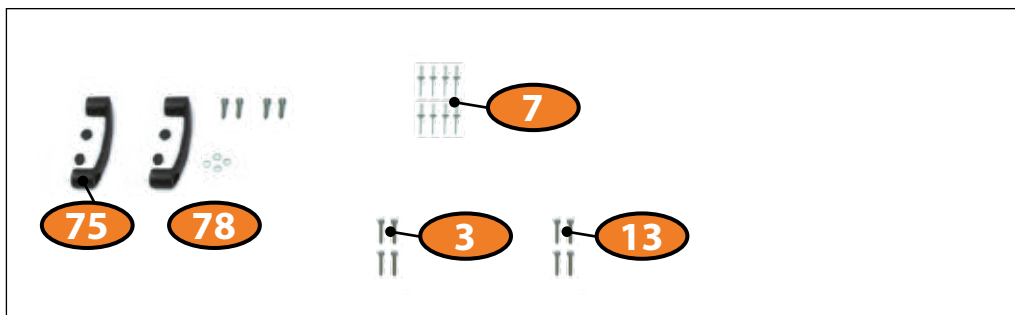

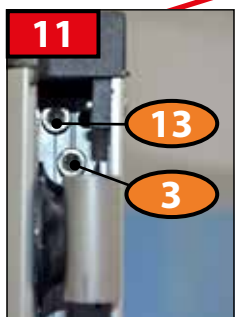
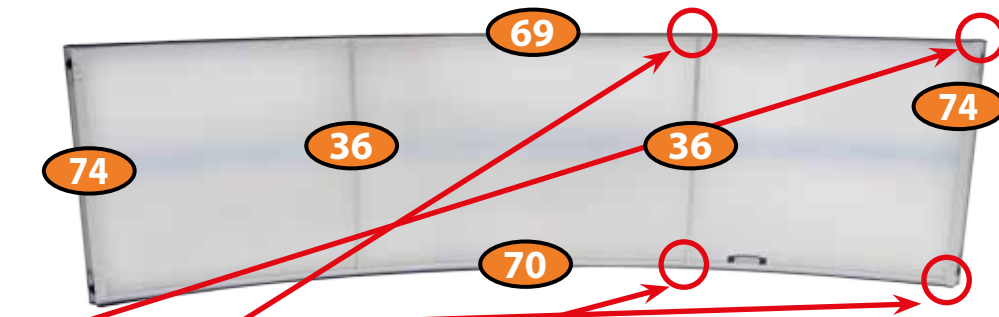
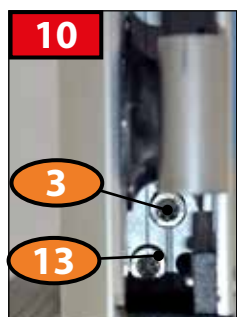
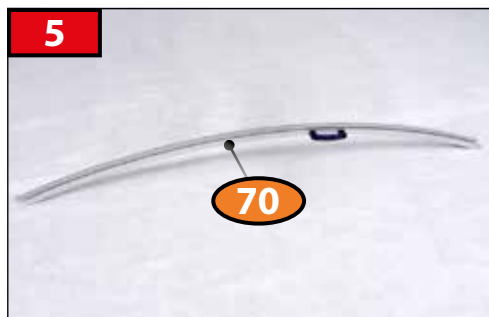
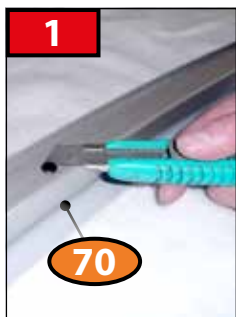

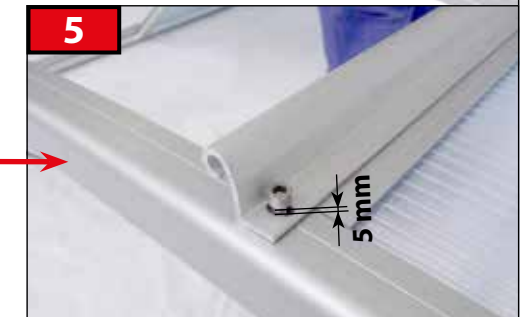
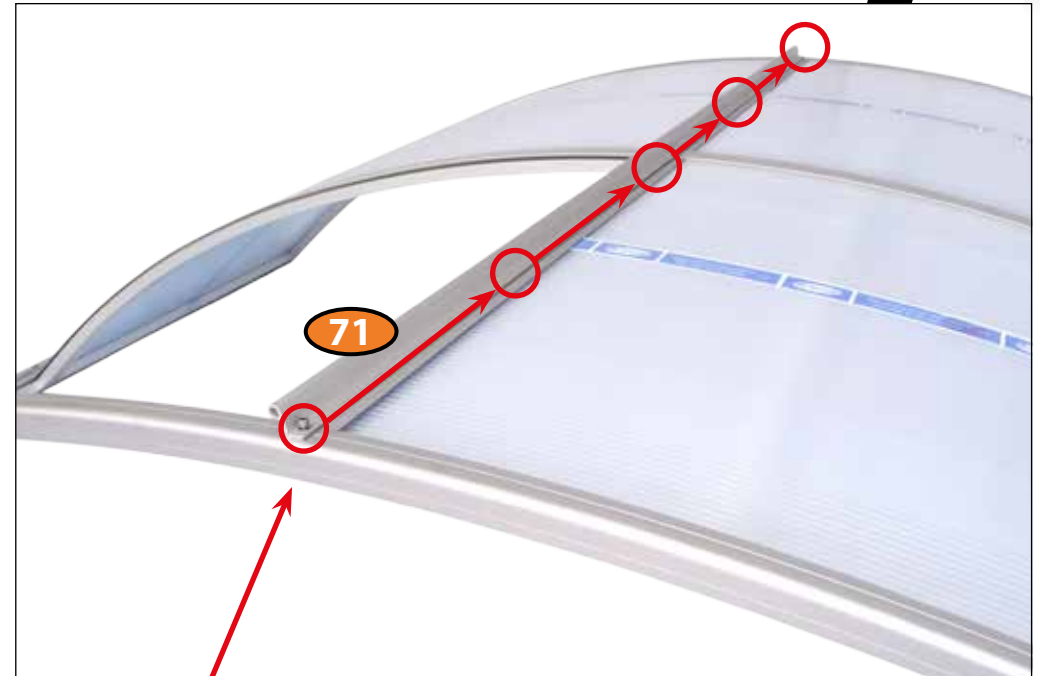

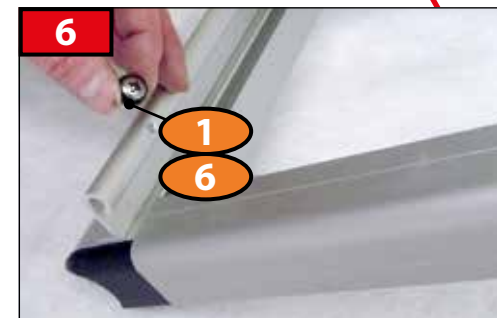
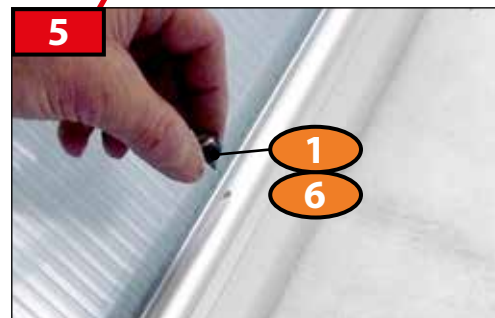
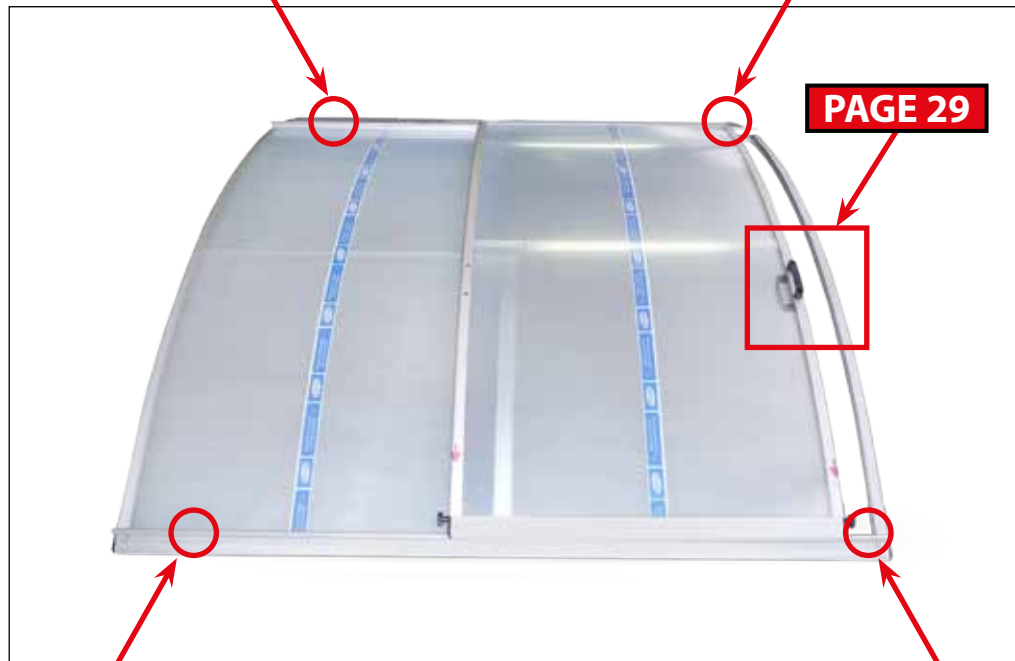
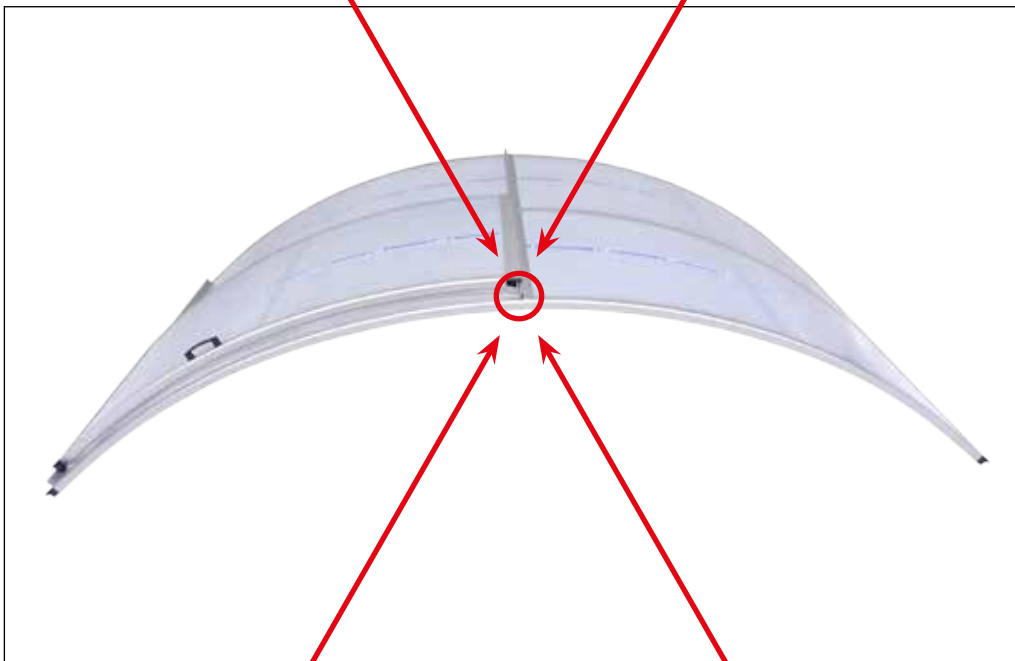

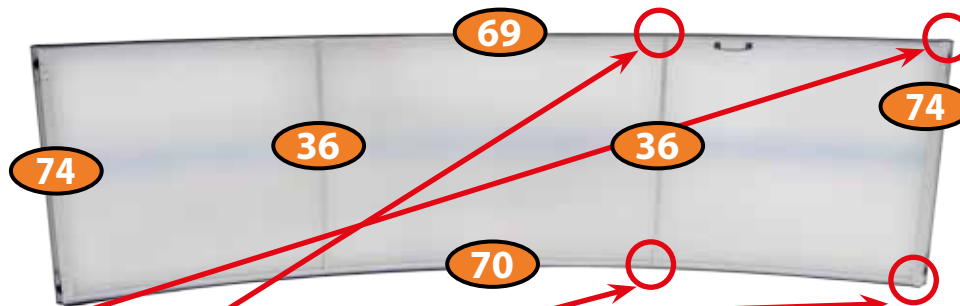
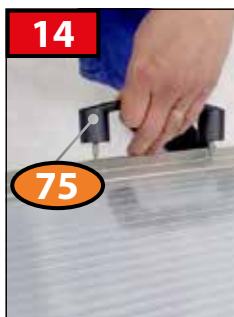
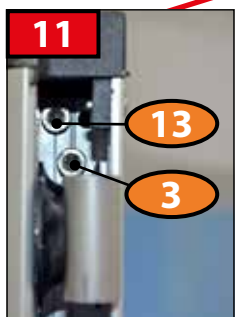
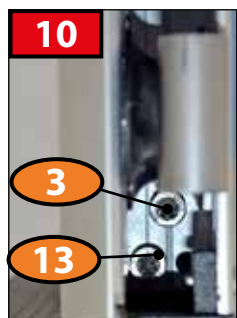

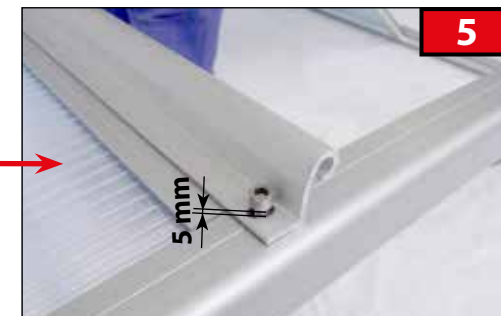
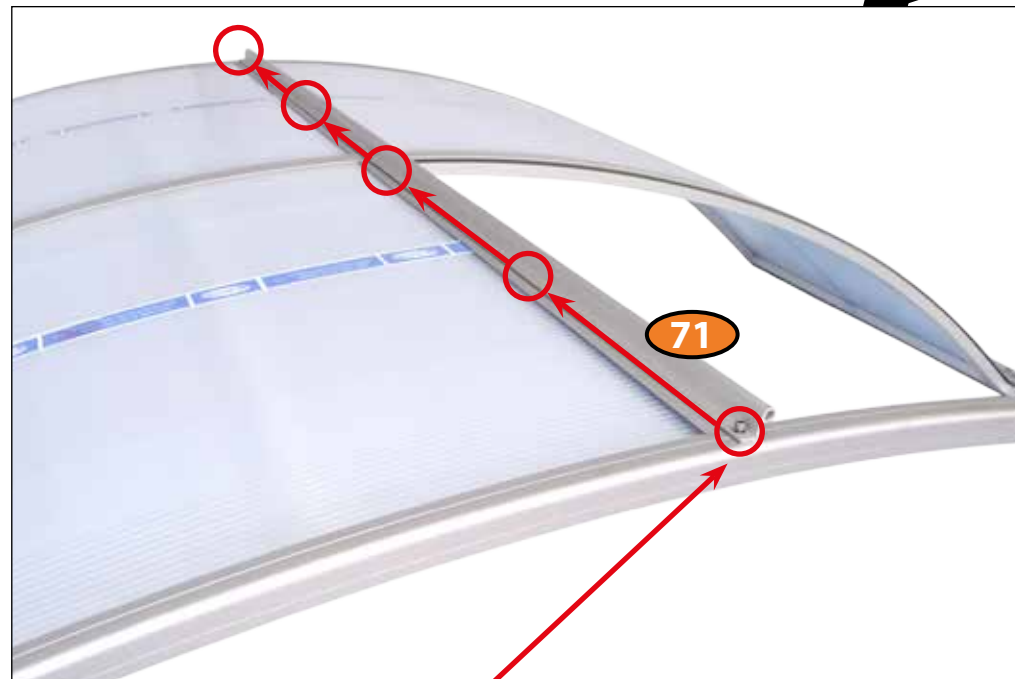

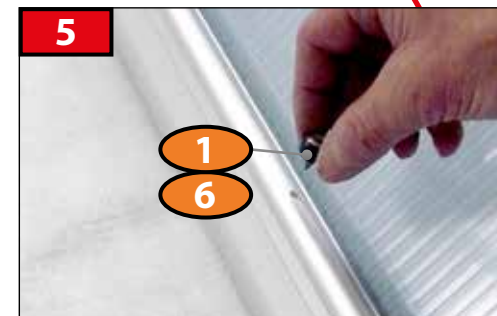
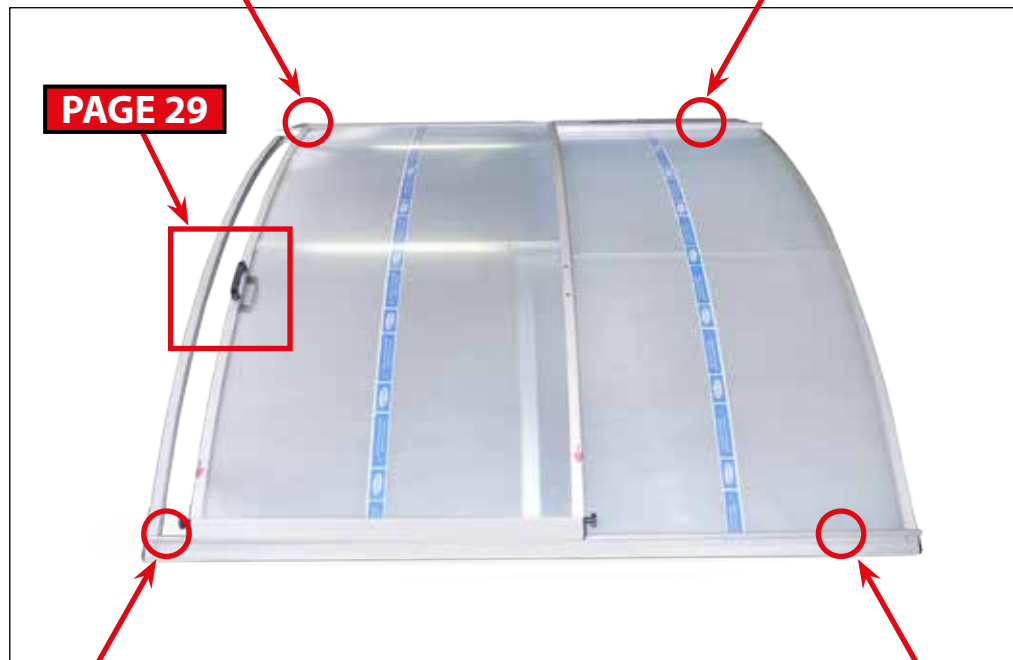
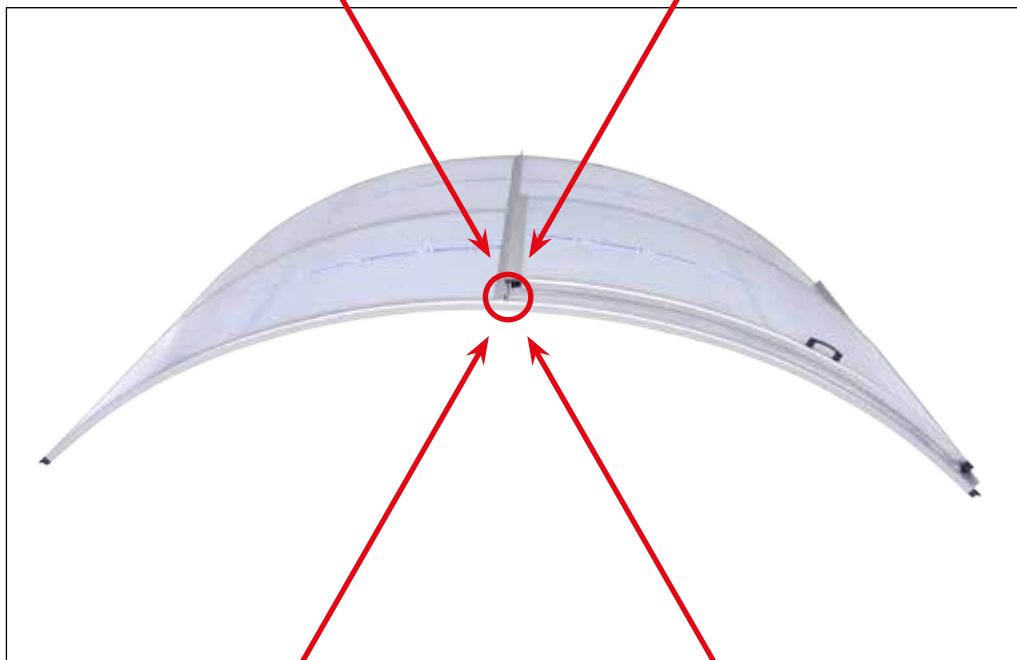
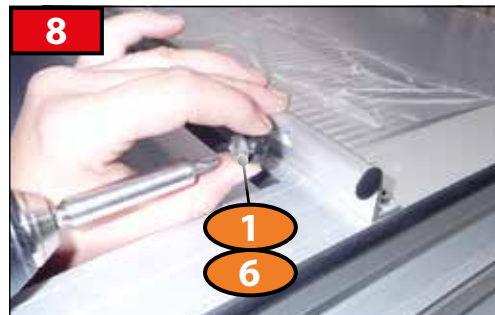

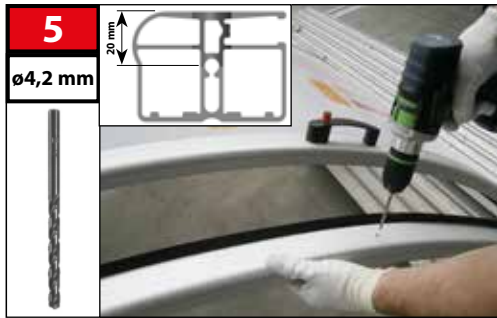

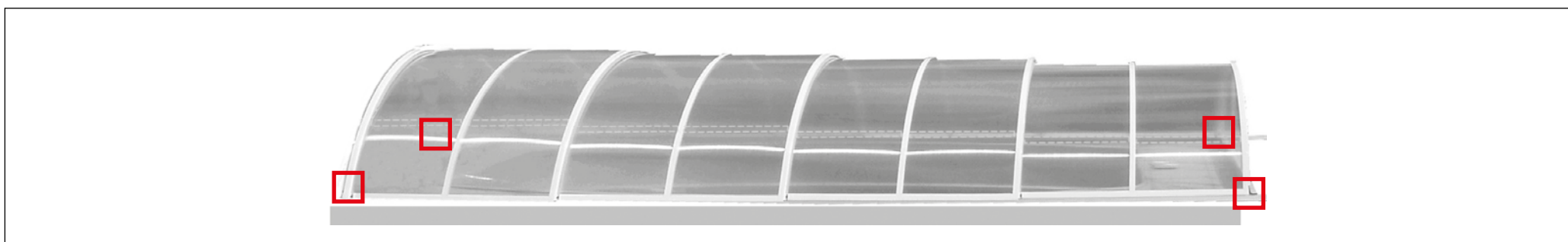
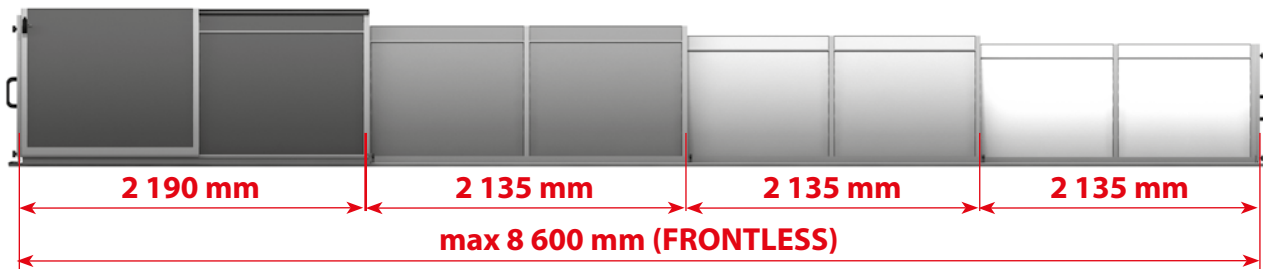

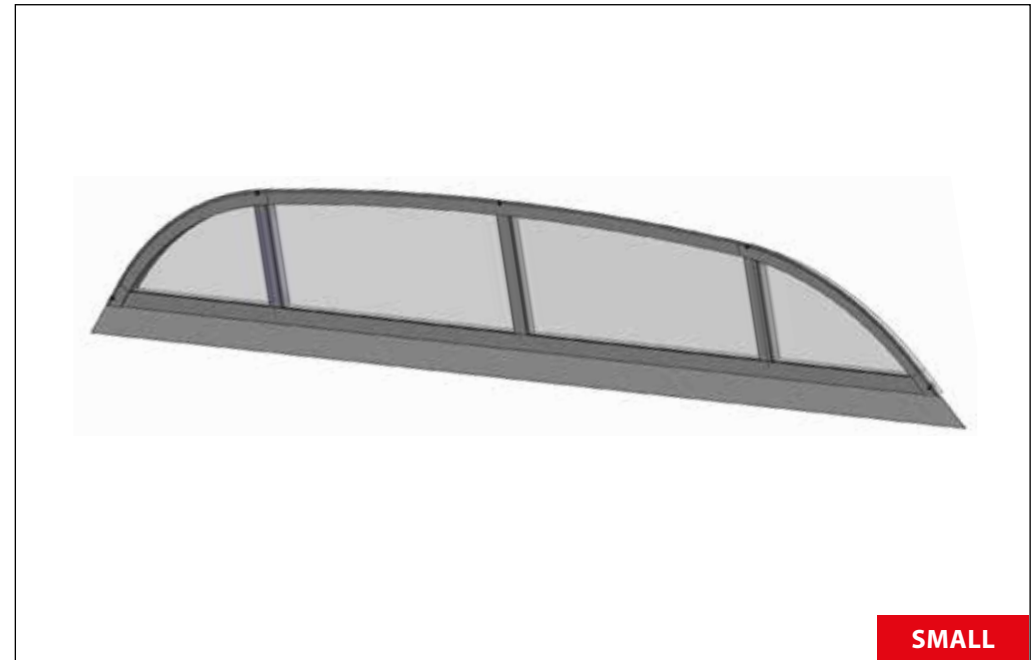
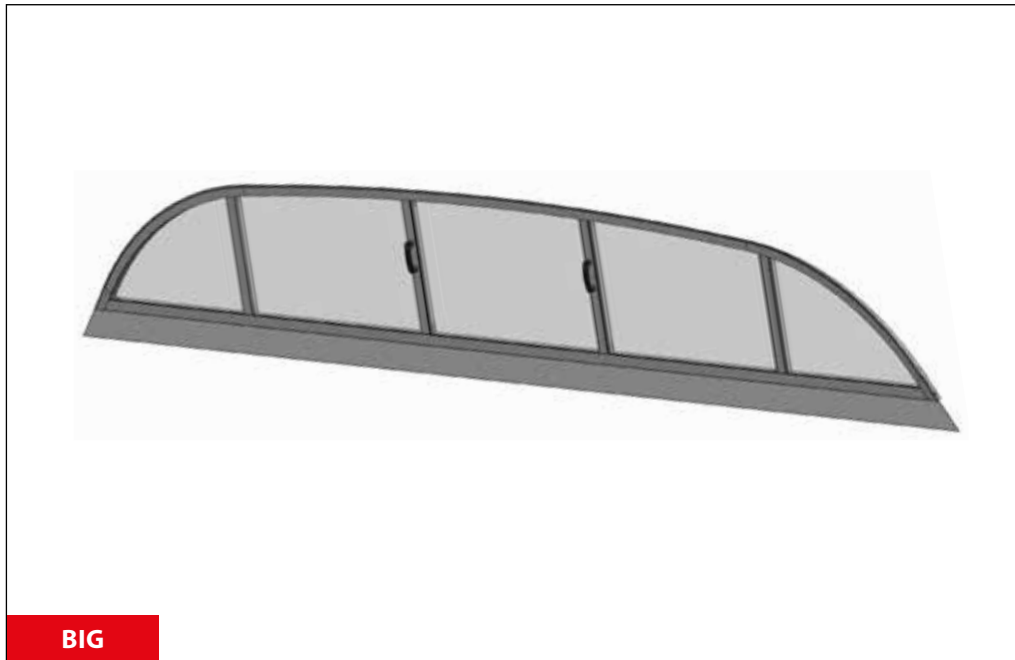

CZ

Dodavatel si vyhrazuje právo na změny a úpravy technických parametrů uváděných v tomto katalogu s ohledem na technický vývoj a zdokonalení výrobků a balení. Dodavatel si vyhrazuje právo na tiskové chyby a chyby v sazbě. Před montáží si pozorně přečtěte návod. Návod si uchovejte pro pozdější použití.

DE

Der Lieferant behält sich das Recht auf Änderungen und Anpassungen der technischen Parameter, die in diesem Katalog aufgeführt sind, mit Rücksicht auf die technische Entwicklung und Verbesserung der Produkte und Verpackung vor. Der Lieferant behält sich das Recht auf Druckfehler und Fehler im Satz vor. Vor der Montage lesen Sie bitte die Anleitung sorgfältig durch. Bewahren Sie die Anleitung für spätere Verwendung auf.

EN

The supplier reserves the right for modifications and adaptations of the technical parameters stated in this catalogue, considering the technical development and upgrade of the products and packaging. The supplier reserves the right for print errors and typographical errors. Please read the manual carefully before you will start the installation. Keep the manual for later use.

ES

El proveedor se reserva el derecho de hacer cambios y modificaciones técnicas de los parámetros que figuran en este catálogo, con respecto al desarrollo técnico mejorando los productos y embalajes. El proveedor se reserva también el derecho a errores de impresión y composición. Antes de empezar la instalación, lea atentamente las instrucciones. Guarde las instrucciones para su uso posterior.

FR

Le fabricant se réserve le droit de modifier les paramètres techniques cités dans ce manuel en considération du développement technique et de l'amélioration des produits et de leur emballage. Le fabricant se réserve le droit des fautes d'impression et de composition. À lire attentivement et à conserver pour une consultation ultérieure.

HU

Gyártó fenntartja jogát a katalógusban feltüntetett műszaki paraméterek változtatására a termékek és csomagolás technikai fejlesztése és tökéletesítése szerint. Szállító: a szállító fenntartja jogát a nyomtatási és szedési hibákra.

IT

Il fornitore si riserva il diritto di effettuare modifiche e correzioni ai parametri tecnici riportati nel presente catalogo per migliorare e perfezionare dal punto di vista tecnico i prodotti e gli imballaggi. Il fornitore non esclude inoltre l'eventuale presenza di errori di stampa e di impaginazione. Prima dell'installazione, leggere attentamente le istruzioni. Tenere l'istruzione per un uso successivo.

PL

Dostawca zastrzega sobie prawo do zmian oraz dostosowania parametrów technicznych podanych w niniejszym katalogu z uwzględnieniem rozwoju technicznego i udoskonalania produktów oraz opakowań. Dostawca zastrzega sobie prawo do błędów druku oraz typograficznych.

PT

O provedor reserva-se o direito a efectuar alterações e adaptações de parâmetros técnicos mencionados neste catálogo, tendo em consideração o avanço técnico e melhorias de produtos e embalagens. O provedor reserva-se o direito a cometer erros de impressora e de edição.

RO

Furnizorul își rezervă dreptul de a modifica și schimba parametrii tehnici menționați în acest catalog cu privire la evoluția tehnică și perfecționarea produselor și a ambalării. Furnizorul își rezervă dreptul la greșelile de tipar și greșelile privind tarifele.

RU

Поставщик оставляет за собой право на изменение и исправление технических параметров продукции указанной в этом каталоге, с учетом технического развития, а усовершенствования изделий и его упаковки. Поставщик оставляет за собой право на опечатку в тексте и в ценах. Перед установкой и эксплуатацией изделия внимательно ознакомьтесь с настоящим руководством. Сохраните данное руководство для дальнейшего использования.